

December 2020

# ASAPIO enables SAP® systems for event messaging with Solace PubSub+®



**SAP® Certified**  
Powered by SAP NetWeaver®



# ASAPIO – SAP® Partner for Cloud Integration and Procurement Solutions

**We specialize in integration of cloud systems, SAP procurement solutions and technologies.**

Founded in 2003 and owned by three former SAP fellows, we are today an SAP silver partner with a growing team of SAP application and technology experts. We operate world-wide, with head office in Munich/Germany, various offices across Germany and an own nearshore center.



## Cloud Integration

ASAPIO technology connects SAP systems with cloud applications, event messaging and iPaaS solutions



## Procurement Solutions

Consulting services for  
SAP S/4HANA®  
SAP Ariba®  
SAP Fieldglass®  
SAP Business Suite®/ERP/PLM



## Technology

Software development  
SAP workflows  
ABAP®  
SAP Fiori®  
SAP Cloud Platform®



# What is event messaging and why is it important to SAP customers?

*“Event streaming is the digital equivalent of the human body's central nervous system. It is the technological foundation for the 'always-on' world where businesses are increasingly software-defined and automated, and where the user of software is more software.”*

- Fact is, Event Messaging is everywhere around us, already today:
  - shops and payment providers use event messaging
  - booking a flight uses event messaging
  - delivery tracking uses event messaging
  - connected cars use event messaging
  - ...and many more

→ Getting data from or into SAP systems is required to turn events into revenue



# ASAPIO Integration Add-on enables SAP® systems for cloud integration

**ASAPIO Integration Add-on** connects SAP S/4HANA®, SAP ERP® and other SAP NetWeaver® systems to:

- ✓ cloud applications
- ✓ event messaging
- ✓ any iPaaS solution and REST-enabled application

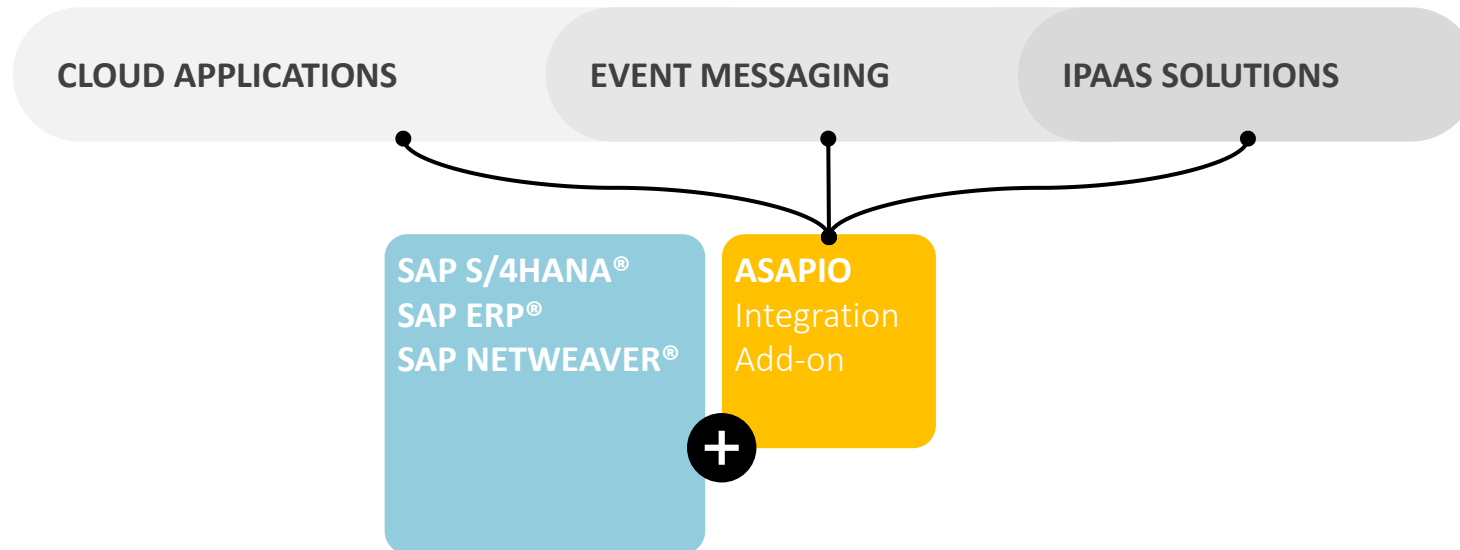

# ASAPIO and Solace® enable SAP® systems for event messaging integration

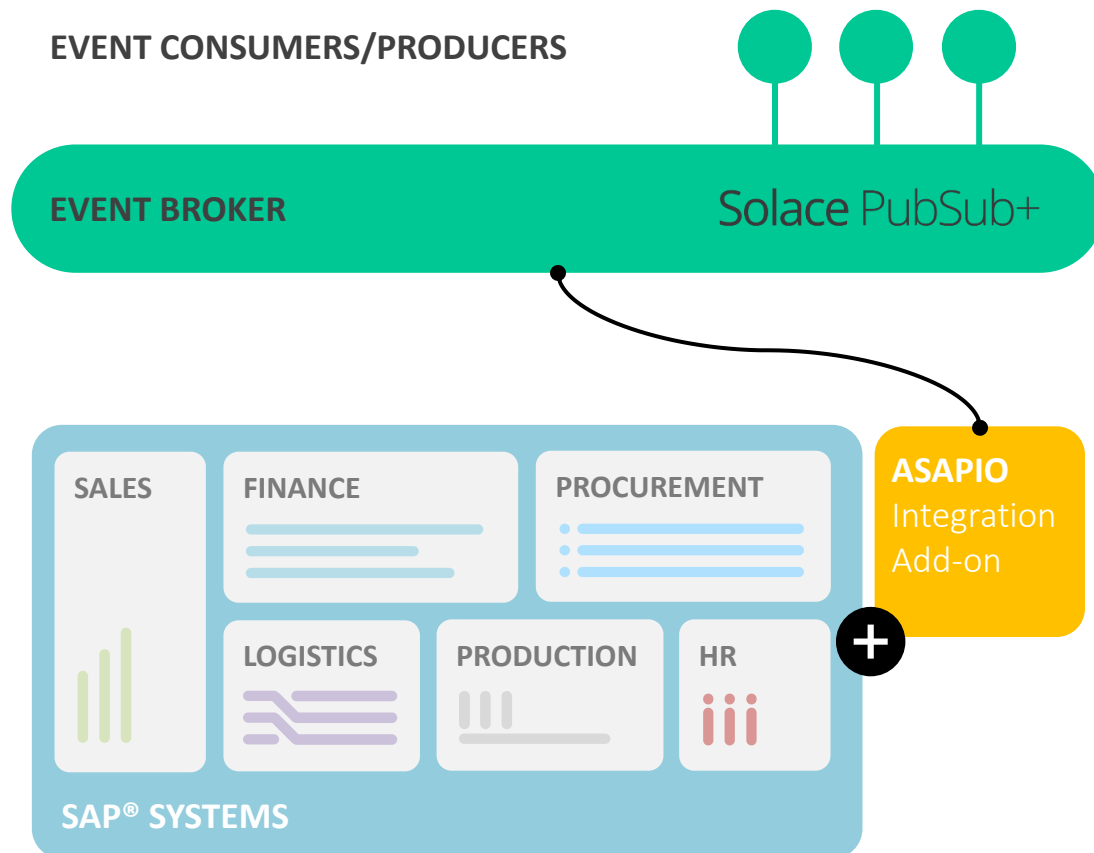

## ASAPIO Integration Add-on is the perfect ETL solution for Solace PubSub+®

- Out-of-the-box connectivity via ASAPIO Solace® PubSub+® Connector
- REST-based outbound and inbound communication
- For cloud and on-prem deployments
- Supports event-driven (single events) and batch mode (multiple events)

## Exclusive features of Solace PubSub+® Connector:

- Dynamic topic generation, based on content data
- Supports high-availability + load-balancing scenarios

# With Solace & ASAPIO, you can send SAP data to any subscribed consumer (and vice-versa), in real-time

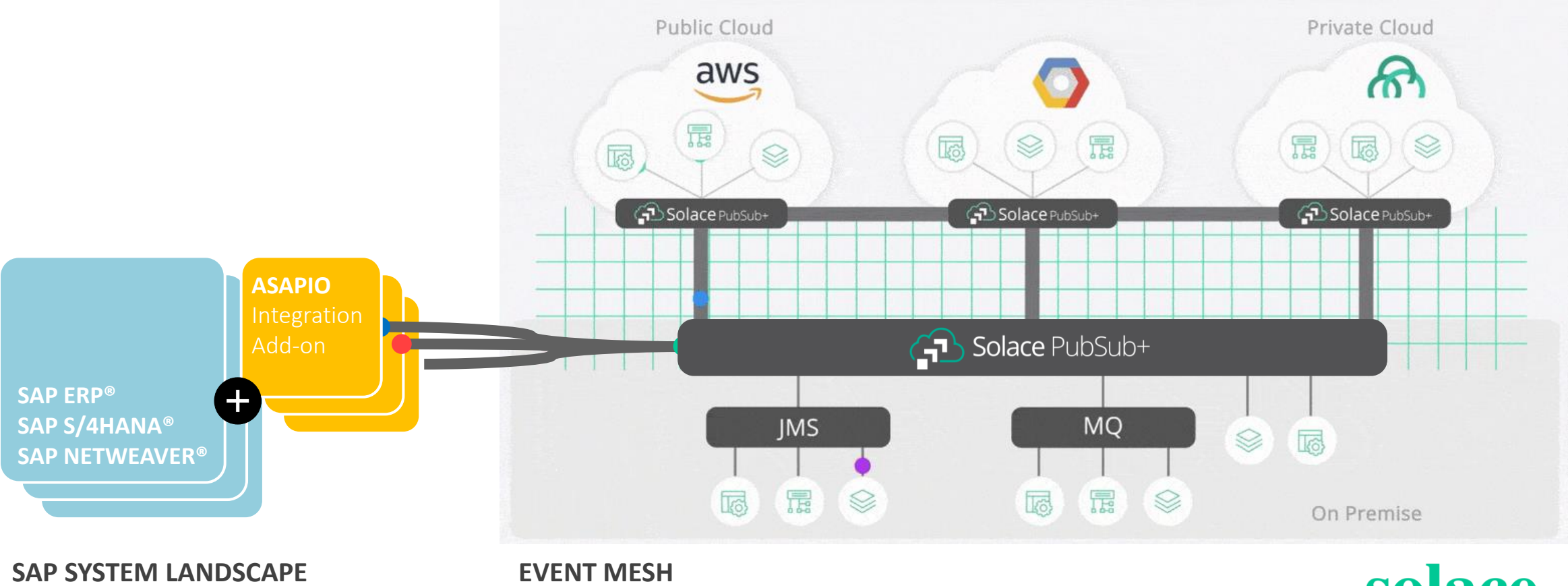

# Outbound event processing with Solace & ASAPIO

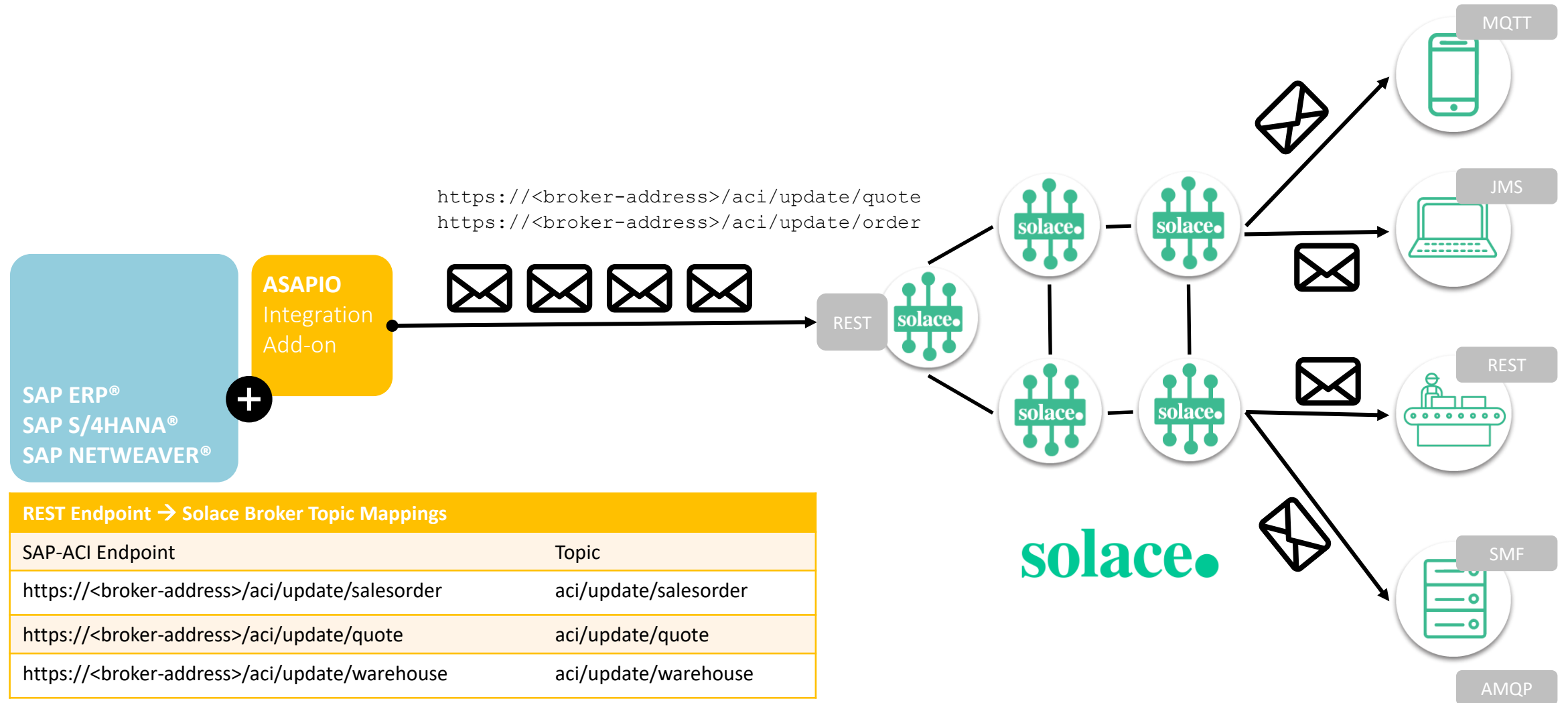

# Inbound event processing with Solace & ASAPIO

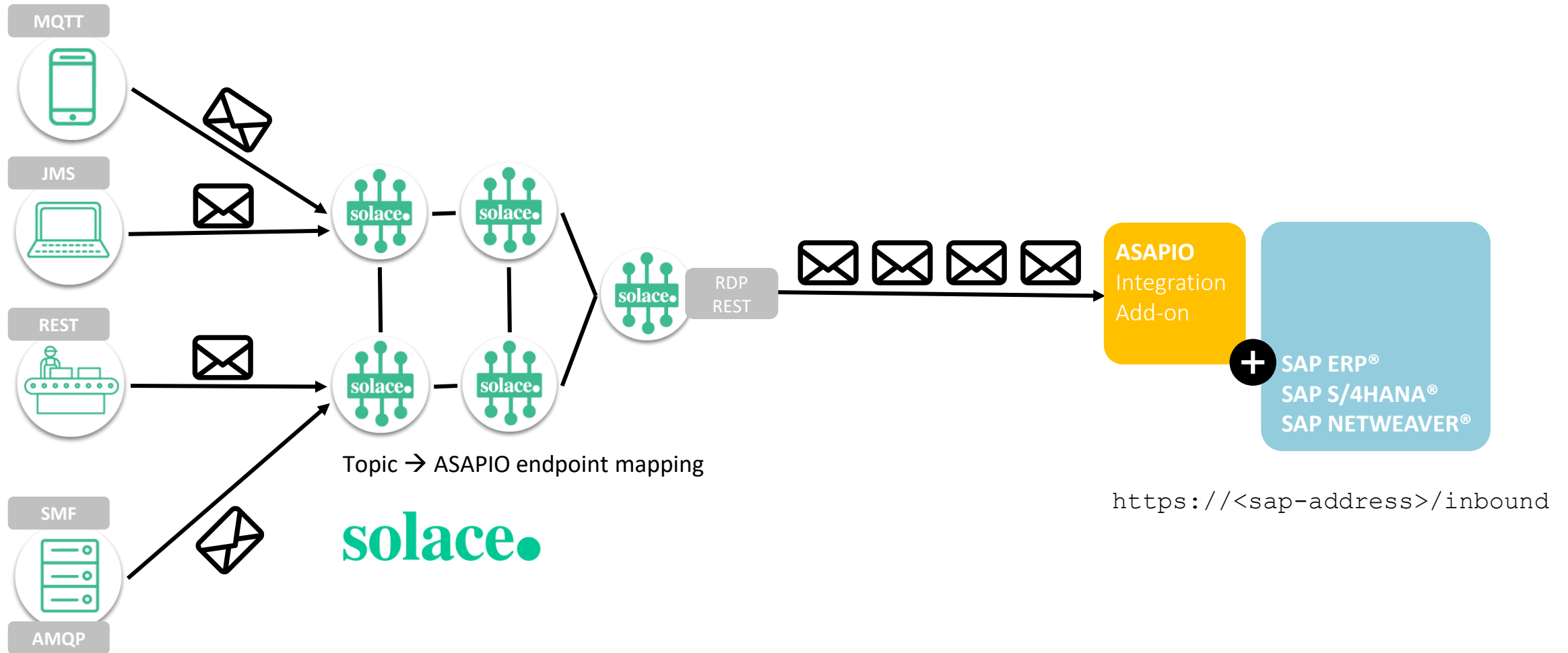



# Secure & Scalable Cloud Integration

- ✓ Solace establishes secure, outbound connections from RZ to PCZ
- ✓ In-line with corporate security policies
- ✓ The SAP system resides in the RZ and is not exposed

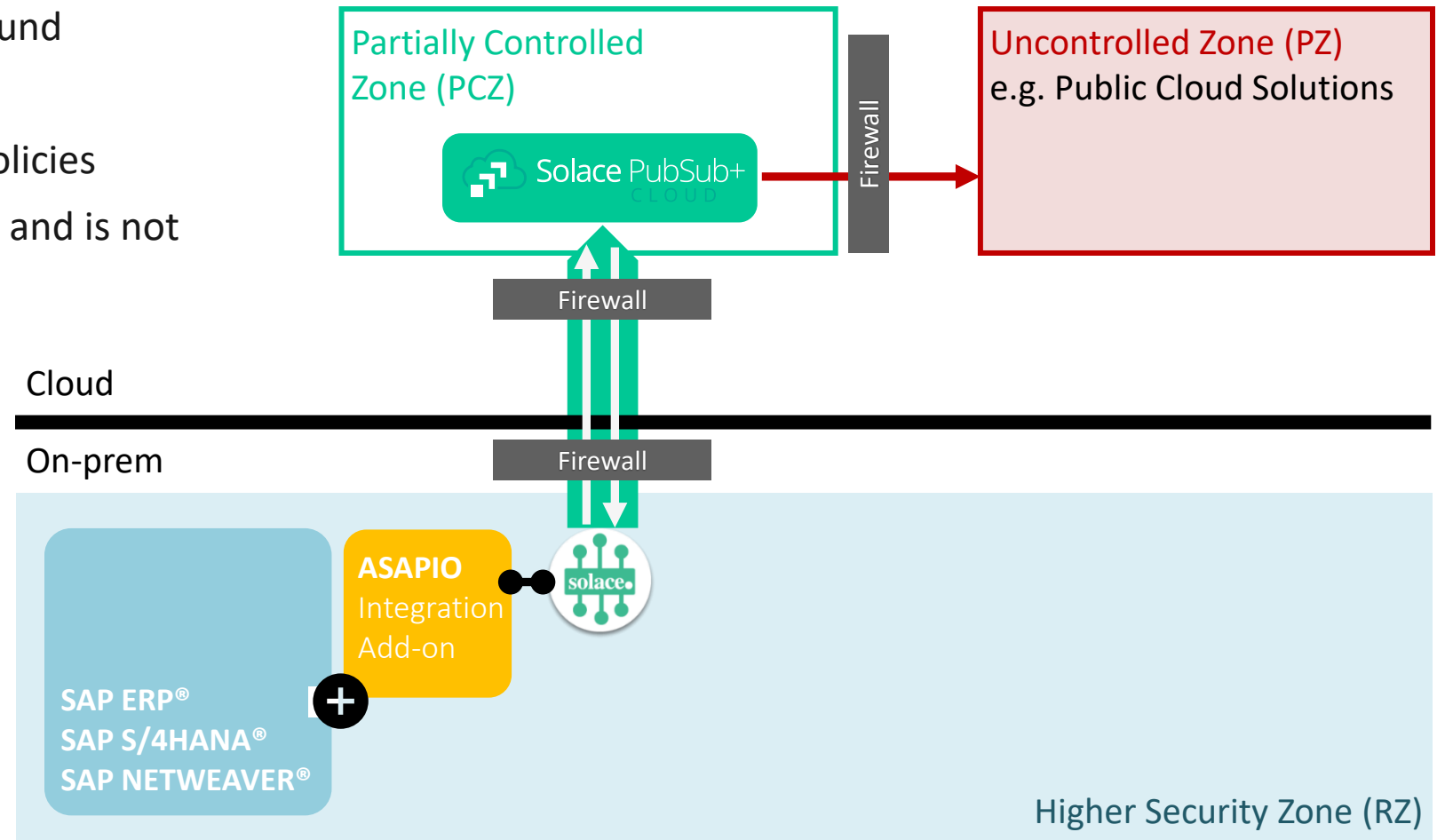

# Benefits of ASAPIO approach compared to others on the market

## Downsides of traditional integration approach:

- Custom API developments required
- iPaaS or middleware required
- No direct data access
- Typically 1:1 connectivity
- Hardly re-usable
- High performance impact

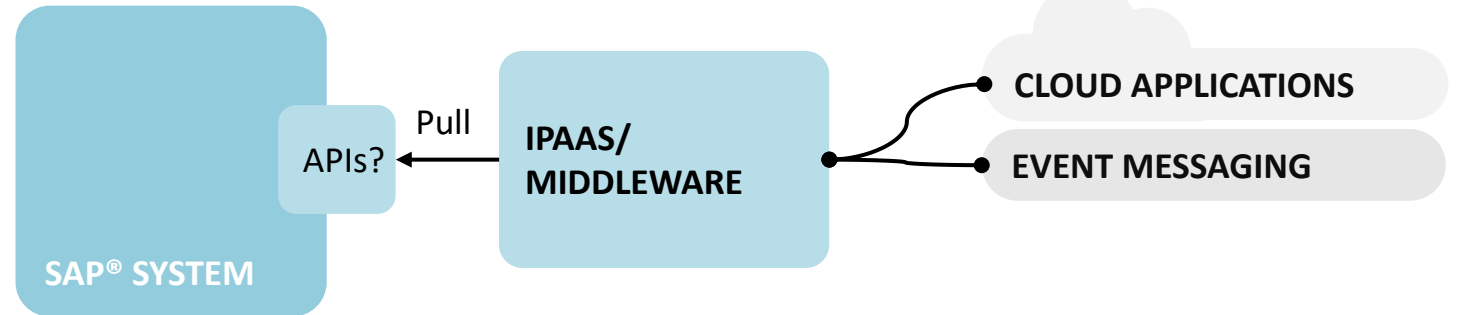

## Benefits of ASAPIO approach:

- Direct application + data access
- 2,500+ standard event triggers
- Supports 1:n connectivity
- Re-usable content
- Close to zero latency
- Multi-threading

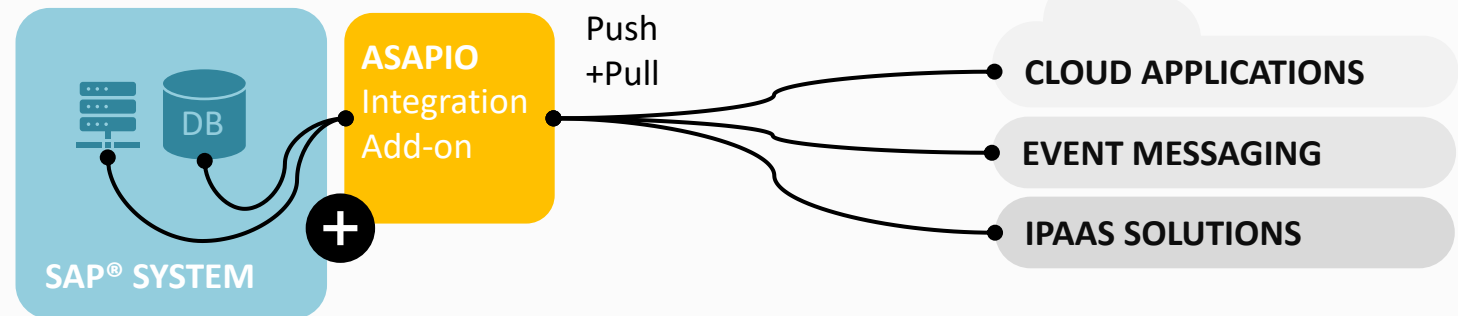

# Architecture / How does it work?

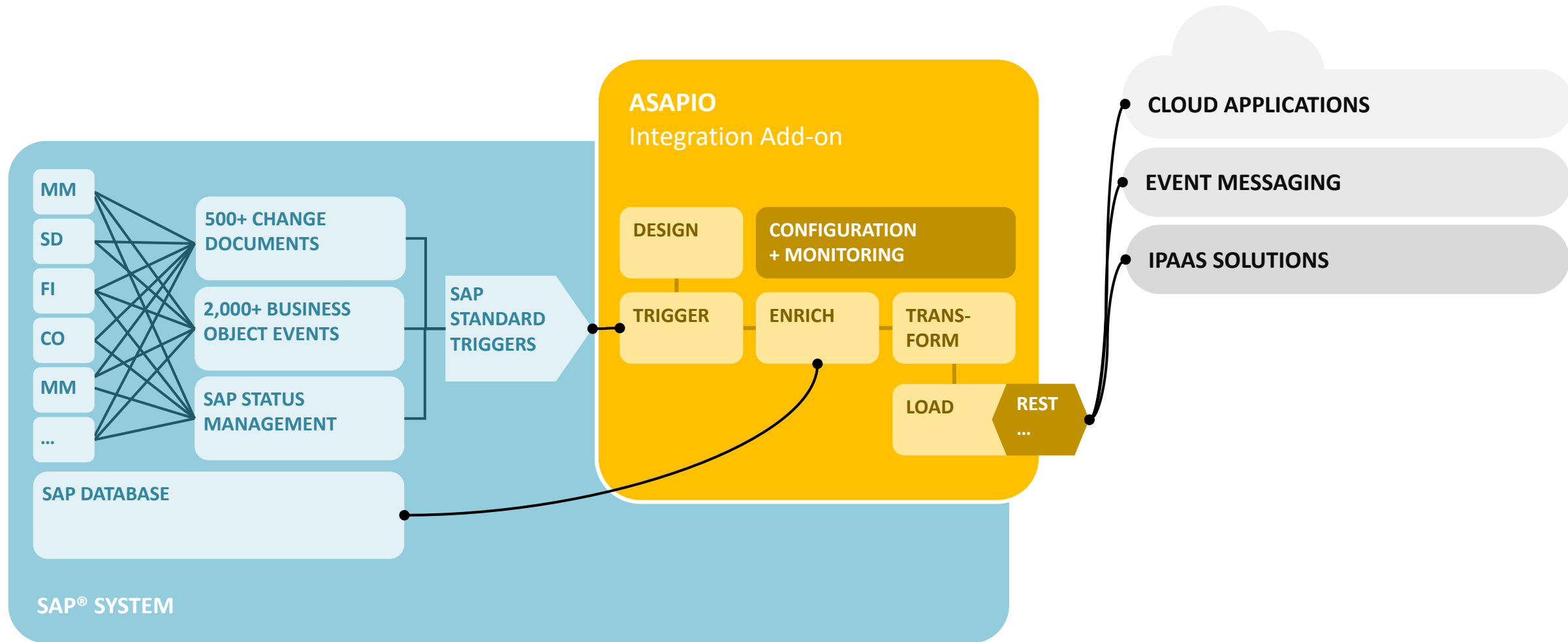

# Simple and code-less message design

## Example: send SAP material master data as event message

- ✓ Specify an SAP Data Dictionary view
- ✓ Add (multiple tables) like MARA and the required fields for the message
- ✓ Table relations and foreign keys are automatically considered
- ✓ Configure ASAPIO Integration Add-on to use the view

View field	Table	Field	Key	Data elem.
MANDT	MARA	MANDT	<input checked="" type="checkbox"/>	MANDT
MATERIAL_NUMBER	MARA	MATNR	<input checked="" type="checkbox"/>	MATNR
ADDITIONAL_UNIT	MARM	MEINH	<input checked="" type="checkbox"/>	LRMEI
MTART	MARA	MTART	<input type="checkbox"/>	MTART
MATKL	MARA	MATKL	<input type="checkbox"/>	MATKL
UMREZ	MARM	UMREZ	<input type="checkbox"/>	UMREZ
UMREN	MARM	UMREN	<input type="checkbox"/>	UMREN
BASE_UNIT	MARA	MEINS	<input type="checkbox"/>	MEINS
EAN11	MARM	EAN11	<input type="checkbox"/>	EAN11
BRGEW	MARM	BRGEW	<input type="checkbox"/>	BRGEW
GEWEI	MARM	GEWEI	<input type="checkbox"/>	GEWEI

## EVENT MESSAGE

```
{
  "specversion": "1.0",
  "type": "asapio.aci.events01.msctest",
  "source": "SAP_EM/MATERIAL_CHANGE",
  "id": "MATERIAL_CHANGE2020110322541650 ",
  "time": "2020-11-03T22:54:15.565Z",
  "data": {
    "MARA": [
      {
        "MANDT": "100",
        "MATERIAL_NUMBER": "CP_5001",
        "MTART": "FERT",
        "MATKL": "015",
        "BASE_UNIT": "ST",
        "MARM": [
          {
            "ADDITIONAL_UNIT": "KAR",
            "UMREZ": 15,
            "UMREN": 1,
            "EAN11": "4015000267397",
            "BRGEW": 3.750,
            "GEWEI": "KG"
          }
        ]
      }
    ]
  }
}
```

# Customer business use-cases

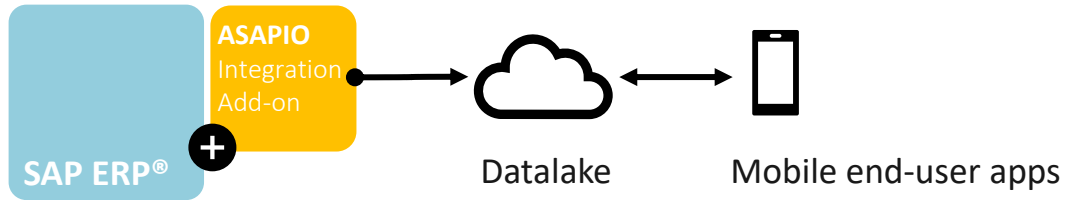

## Sales + logistics data (Large chemical company)

ASAPIO provides high-volume data (SAP sales orders and logistics info) to a data lake, for buffered data provisioning to end-customer mobile apps

Live Customer

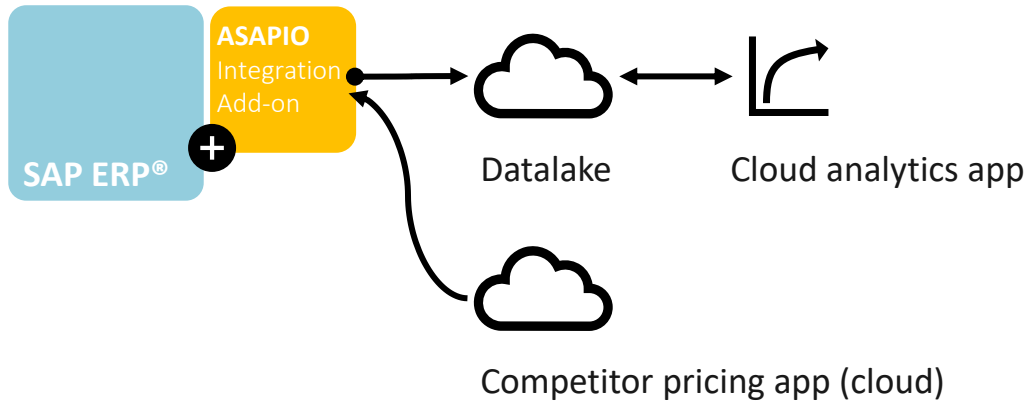

## Sales data (Retail industry customer)

Send SAP data to data lakes for real-time analytics during high-volume promotions (Black Friday)

Live Customer

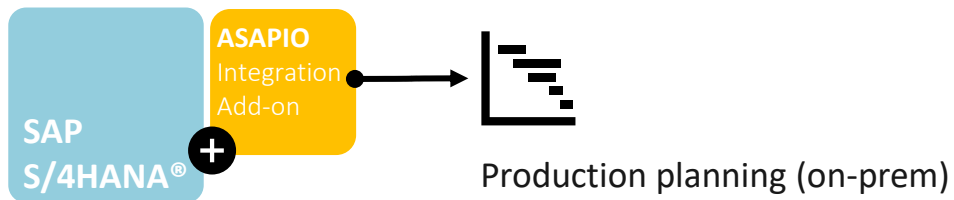

## Product pricing data

Inbound process, for event-driven load of competitor pricing into SAP ERP®, for automated price benchmarking

PoC ongoing

## Production planning data (Automotive customer)

Event-driven transfer of central SAP S/4HANA® production planning data to non-SAP fine-planning solutions. High data-volumes expected, process stability is critical.

PoC ongoing

# ASAPIO Integration Add-on – the ‘Swiss army knife’ for interfaces

- ✓ Create code-less APIs and event messages for any SAP® data
- ✓ SAP-certified and licensable from SAP (for selected scenarios)
- ✓ Direct access to *any* SAP business object and *all* database tables
- ✓ Use over 2,500 standard event triggers in SAP ERP® and SAP S/4HANA®
- ✓ Packaged business content available
- ✓ Extensible by customers and partners



***Faster results***



***Lower project risk***



***Higher quality***

# ASAPIO Integration Add-on is available from Solace and ASAPIO

ASAPIO  
Integration  
Add-on



**ASAPIO**  
Integration  
Add-on

Subscription includes:  
ACI Framework  
+ Solace® Connector  
+ Maintenance/SLA  
+ Updates

## **ASAPIO Integration Add-on is offered as a subscription license product**

- License metric is based on number of productive SAP systems and number of configured event messaging objects
- ASAPIO provides support services with SLAs
- Subscription customers are also eligible for any updates/new releases
- ASAPIO Integration Add-on is available from Solace or ASAPIO
- For technical requirements and pricing details please reach out to **ASAPIO or Solace**

## **ASAPIO GmbH & Co. KG**

Munich, Germany

Phone +49 (0)89 4520-744-0

Email [info@asapio.com](mailto:info@asapio.com)

# Disclaimer



These documents are provided by Asapio GmbH & Co. KG (hereinafter ASAPIO) and are for informational purposes only. ASAPIO assumes no liability or warranty for errors or omissions in this publication. ASAPIO only provides products and services as expressly set forth in the agreement for the respective products and services. None of the information contained herein is to be interpreted as an additional guarantee.

In particular, ASAPIO is under no obligation to follow any of the business operations outlined in this publication or any accompanying presentation, or to develop or publish features hereof.

The information contained in this publication does not constitute a promise, promise or legal obligation to deliver software. All forward-looking statements involve various risks and uncertainties that could cause actual results to differ materially from expectations. The forward-looking statements reflect the point in time when they were made. The reader is advised not to give excessive weight to these statements or to rely on them when making purchasing decisions.

Trademark Information: SAP, SAP S/4HANA, SAP SRM, SAP ERP, SAP Business Suite, SAP Ariba, SAP Fieldglass and other SAP product or technology names are the trademarks or registered trademarks of SAP SE in Germany and several other countries.